

GENERAL DESCRIPTION

M42A3729H8 -C is an omnidirectional, Top-ported, analog output MEMS microphone. It has high performance and reliability. It is with enhanced RF immunity performance .

M42A3729H8 -C is available in a thin 3.76 mm × 2.95 mm × 1.1 mm metal cap LGA package. It is SMT compatible with no sensitivity degradation.

FEATURES

- ✧ Low Noise
- ✧ Omnidirectional
- ✧ Excellent RF immunity
- ✧ Standard SMD Reflow
- ✧ Compatible with Sn/Pb and Pb-free solder processes
- ✧ RoHS/Halogen free compliant

APPLICATIONS

- ✧ Mobile Phone
- ✧ Laptop
- ✧ Tablet computer
- ✧ Bluetooth headset
- ✧ Earphone
- ✧ Wearable intelligent equipment

PRODUCT VIEW

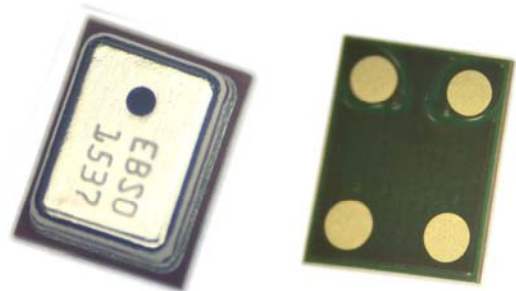

ABSOLUTE MAXIMUM RATINGS

Parameter	Maximum value	Unit
Supply Voltage	-0.3 to 4.0	V
Sound Pressure Level	140	dB SPL
Mechanical Shock	10,000	g
Temperature Range	-40 to 100	°C
Electrostatic discharge protection	2 (HBM)	kV

Stresses exceeding these “Absolute Maximum Ratings” may cause permanent damage to the device. These are stress ratings only. Functional operation at these or any other conditions beyond those indicated under “Acoustic & Electrical Specifications” is not implied. Exposure beyond those indicated under “Acoustic & Electrical Specifications” for extended periods may affect device reliability.

ACOUSTIC & ELECTRICAL SPECIFICATIONS

All data taken at 25°C, Relative Humidity 45±5% unless otherwise specified					
	Limits			unit	condition
	Min.	Nom.	Max.		
Directivity	Omni directional				
Sensitivity	-45	-42	-39	dB	@1kHz ref 1V/Pa
Operation voltage	1.5	-	3.6	V	
Freq. range	Refer to the frequency response graphic			Hz	Ref to sensitivity@1kHz
Sensitivity loss across supply voltage	No change across the voltage range			dB	
Signal to noise ratio	-	59	-	dB	20 kHz bandwidth, A-weighted
THD	-	-	1	%	100dB SPL @1kHz S =Nom, Rload > 2 k
AOP	-	130	-	dB SPL	10% THD @1kHz S =Nom, Rload > 2 k
Polarity	Increasing output voltage				Increasing sound pressure
Output impedance	-	200	-	Ω	@1kHz
DC Output		0.7		V	
PSRR	-	60	-	dB	200mVpp sine wave @ 1 kHz, VDD = 1.8V
PSR	-	-92	-	dBV(A)	100 mVpp square wave@ 217 Hz, VDD = 1.8V, A-weighted
Current consumption	-	160	180	μA	
Operating temperature	-40	-	100	°C	
Storage temperature	-40	-	100	°C	

TYPICAL FREQUENCY RESPONSE

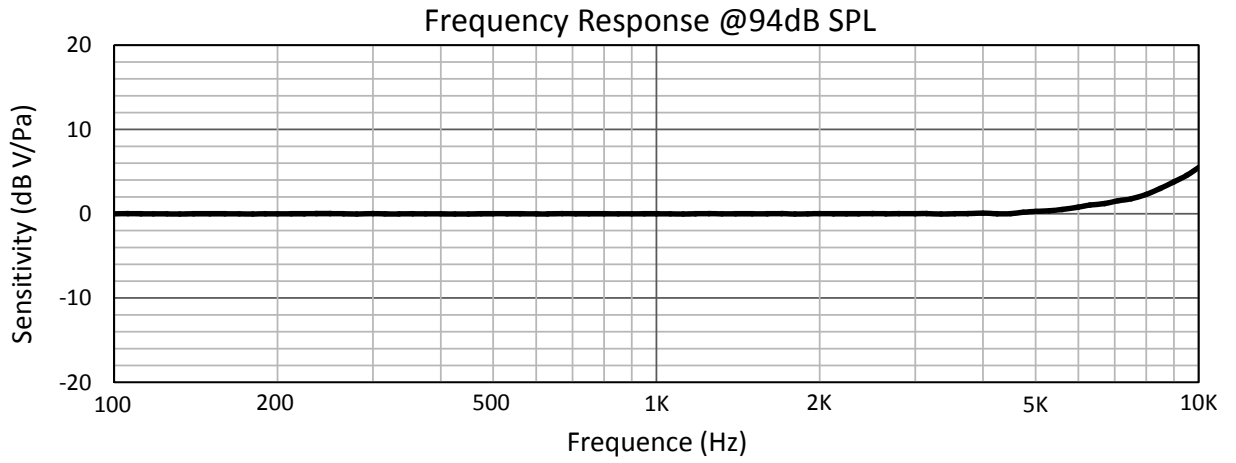

SMT Parameters:

1. Recommend PCB land pattern layout: (unit: mm)

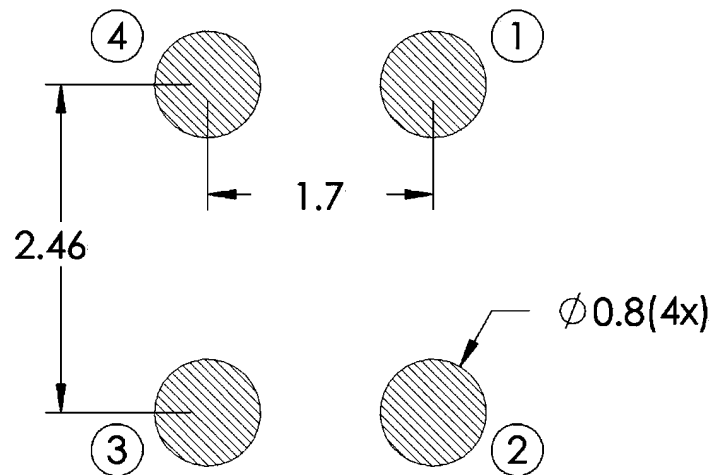

2. Recommend reflow profile:

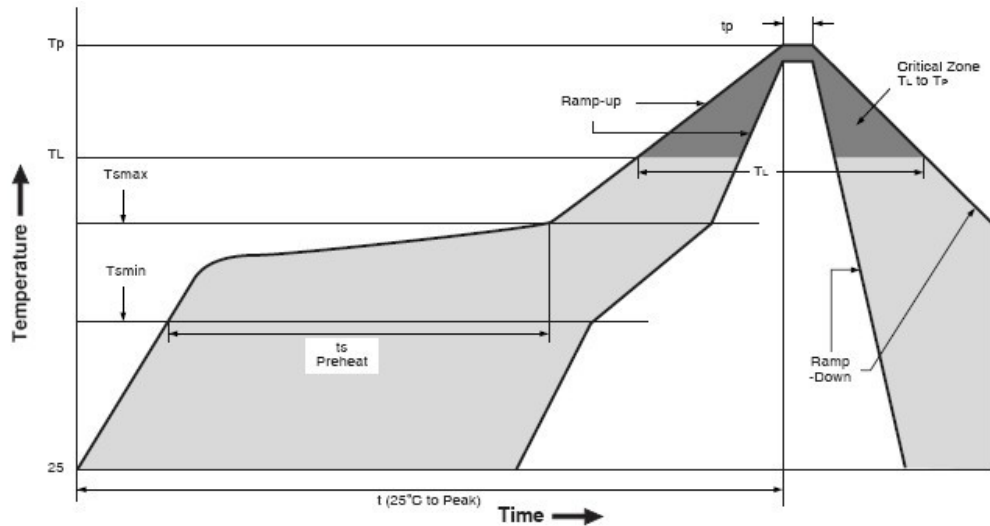

Description	Parameter	Pb-free
Average ramp-up rate	T_{smax} to T_p	3°C/sec max
Preheat		
Minimum temperature	T_{SMIN}	150 °C
Maximum temperature	T_{SMAX}	200 °C
Time(T_{SMIN} to T_{SMAX})	t_s	60 sec to 180 sec
Ramp-up rate	T_{SMAX} to T_L	1.25 °C/sec
Time maintained above liquidus temperature	t_L	60 sec to 150 sec
Liquidus temperature	T_L	217 °C
Peak temperature	T_p	260 °C
Time within 5°C of actual peak temperature	t_p	20 sec to 40 sec
Ramp-down rate	T_p to T_{smax}	6 °C/sec max
Time 25 °C ($t_{25 °C}$) to peak temperature	t	8 minutes max

OUTLINE DIMENSIONS AND PIN DEFINITION:

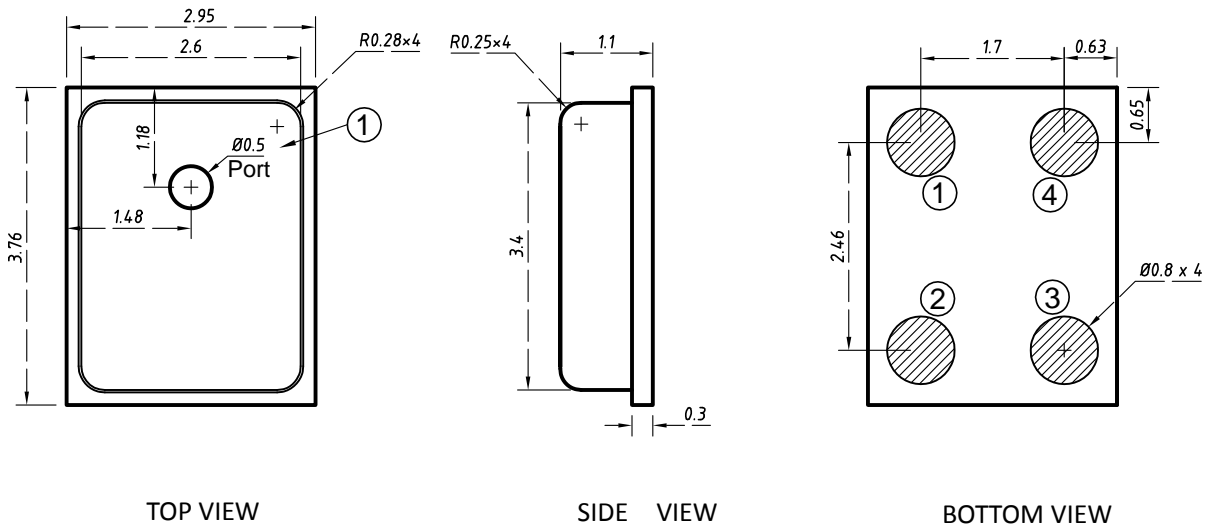
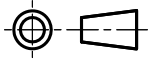

PIN function description

PIN#	Function
1	VDD
2	GND
3	GND
4	OUT

Item	Dimension	Tolerance
Length (L)	3.76	± 0.10
Width (W)	2.95	± 0.10
Height (H)	1.10	± 0.10
Acoustic Port (AP)	$\varnothing 0.5$	± 0.05

Dimensions are in millimeters
Tolerance is ± 0.15 mm unless otherwise specified.

RECOMMENDED INTERFACE CIRCUIT:

- Recommended Application Example (differential amplification circuit)

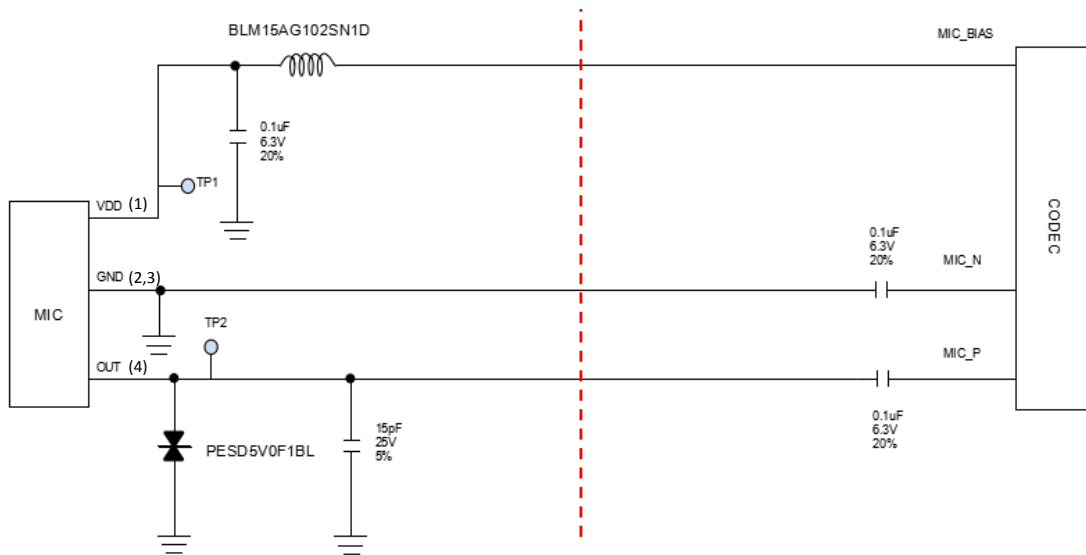

NOTE: It is recommended that the components on the left side of red line be placed close to MIC, and components on the right side of red line be placed close to codec.

ADDITIONAL NOTES

(A) MSL (moisture sensitivity level) Class 2a.

(B) Maximum of 3 reflow cycles is recommended.

(C) In order to minimize device damage:

Do not board wash or clean after the reflow process.

Do not brush board with or without solvents after the reflow process.

Do not directly expose to ultrasonic processing, welding, or cleaning.

Do not insert any object in port hole of device at any time.

Do not apply air pressure into the port hole.

Do not pull a vacuum over port hole of the microphone.

MATERIALS STATEMENT

Meets the requirements of the European RoHS and Halogen-Free.

RELIABILITY SPECIFICATIONS

Test	Description
Thermal Shock	100 cycles air-to-air thermal shock from -40°C to +125°C with 15 minute soaks. (IEC 68-2-4)
High Temperature Storage	1,000 hours at +105°C environment (IEC 68-2-2 Test Ba)
Low Temperature Storage	1,000 hours at -40°C environment (IEC 68-2-2 Test Aa)
Reflow	5 reflow cycles with peak temperature of +260°C
ESD-HBM/LID-GND	3 discharges of ±2 kV direct contact to I/O pins. (MIL 883E, Method 3015.7)& 3 discharges of ±8 kV direct contact to lid while unit is grounded. (IEC 61000-4-2)
ESD-MM	3 discharges of ±200 V direct contact to I/O pins. (ESD STM5.2)
Vibration	4 cycles of 20 to 2,000 Hz sinusoidal sweep with 20 G peak acceleration lasting 12 minutes in X, Y, and Z directions. (Mil-Std-883E, Method 2007.2 A)
Mechanical Shock	3 pulses of 10,000 G in the X, Y and Z direction (IEC 68-2-27, Test Ea)
High Temperature Bias	1,000 hours at +105°C under bias (IEC 68-2-2 Test Ba)
Low Temperature Bias	1,000 hours at -40°C under bias (IEC 68-2-2 Test Aa)
Temperature/Humidity Bias	1,000 hours at +85°C/85% R.H. under bias. (JESD22-A101A-B)
Drop Test	To be no interference in operation after dropped to 1.0cm steel plate 18 times from 1.5 meter height

NOTE:Sensitivity should vary within ±3dB from initial sensitivity. (The measurement to be done after 2 hours of conditioning at 20±2°C, R.H 60%~70%)

REVISION HISTORY:

Revision	Subjects (major changes since last revision)	Date
1.0	Initial Release	2014-06-01
1.1	Modified the reflow parameter	2015-01-26
1.2	Modified the outline dimension	2015-02-12
1.3	Modified MSL class and the package of product	2015-11-18